

Upper sections for yard drains

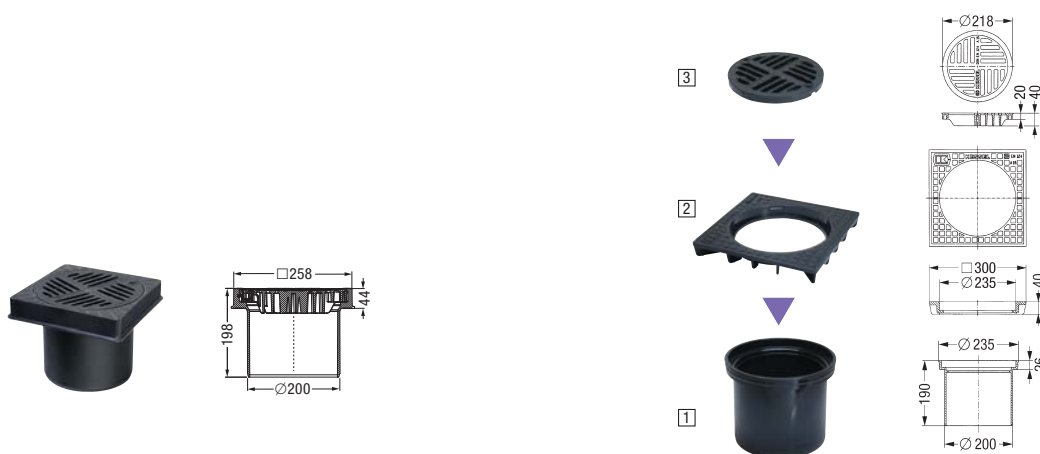

in *Ecoguss*

upper section with support rim  $\square$  250 mm and round slotted cover  $\varnothing$  235 mm, in *Ecoguss*, class B 125, with *Lock & Lift* System, height adjustable from 40 - 150 mm  
Art. # 67 985

in polymer, consists of...

- 1 Upper section height adjustable from 40 - 150 mm  
Art. # 67 400
- 2 Support rim  $\square$  300 mm, class A 15 / L 15  
Art. # 27 180
- 3 Slotted cover  $\varnothing$  218 mm, class A 15 / L 15  
Art. # 27 173

Accessories for yard drains and gutter drains

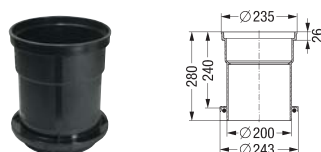

Extension section

made of polymer, installation height 240 mm  
Art. # 67 500

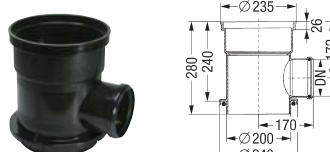

Extension section

made of polymer, with lateral inlet, installation height 240 mm  
Art. # 67 600



Sludge basket

in PE-HD  
Art. # 67 300



Multistop 200

odour, foam, rodent and insect stop for article 67 985, 67 923B, 67 922B  
Art. # 48 520



Lip seal

Art. # 27 140



Lip seal

Non-slip mounting  
Art. # 27 141

Drain body for yard drains and gutter drains

4.5 l/sec flow rate

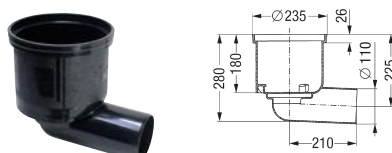

Drain body made of polymer

Lateral outlet 2.5°, without odour trap  
 $\varnothing$  110 Art. # 67 000

Upper sections for gutter drains



in polymer

**Cover plate** Ø 218 mm  
class A 15 / L 15,  
sealed with respect to surface water,  
Art. # 67 775

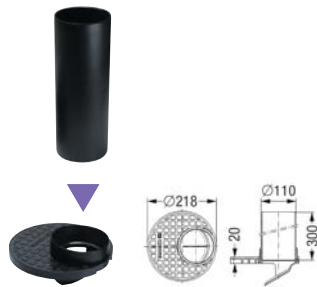

in polymer

**Rain inlet cover** Ø 218 mm  
with protective pipe Ø 110  
Art. # 67 750



in polymer

**Rain inlet slotted cover** Ø 218 mm,  
for additional surface drainage  
with protective pipe Ø 110  
Art. # 67 700

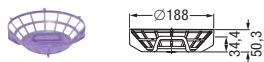

Leaf trap

in PP  
Art. # 48 300

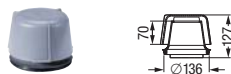

Bell-shaped odour trap insert

in PP, removable,  
sealing water height 70 mm  
Art. # 27 170



Bell-shaped odour trap insert

in PP, removable,  
sealing water height 100 mm  
Art. # 27 171

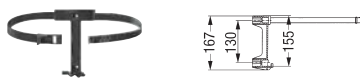

Wall securing device

for gutter drains  
Art. # 67 800

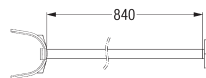

Lifting mechanism

for removing odour trap  
Art. # 850 144



Locking and removal key

for *Ecoguss* drain covers  
with *Lock & Lift* System.  
Art. # 67 007

4.5 l/sec flow rate

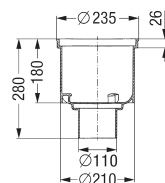

Drain body made of polymer

Vertical outlet, without odour trap  
Ø 110 Art. # 67 040